

EKF 161

Deckel

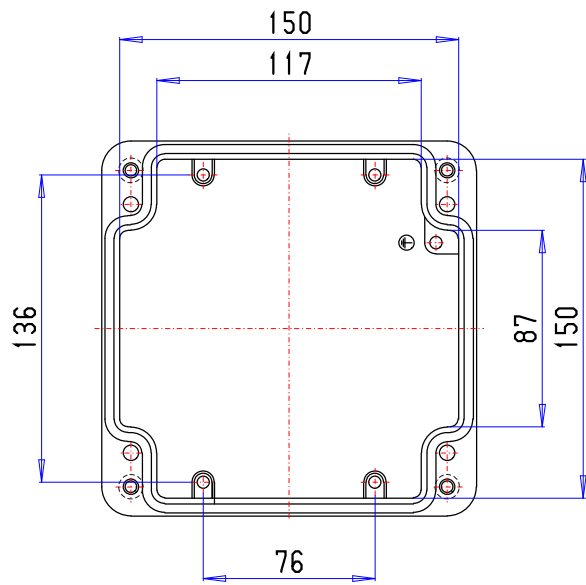

Unterteil

